

My card was cased from an **AMAZING** paper artist Tanu Creative – you can watch her video here <https://youtu.be/gWo0jBCmRLQ> and use the measurements I provide to accompany her video

Step 1 Cut 3 boxes/crates

Step 2 Assemble 3 boxes/crates

Step 3 Cut card base

Step 4 Cut 4 covers & decorate 2 inside covers

Step 5 Glue inside covers to card base (leaving 1 side of left open for insert)

Step 6 Glue medium box on top of large box

Step 7 Dry fit large box inside card to mark placement

Step 8 Use Tear Tape on largest right box to secure to card

Step 9 Close crates and put tear tape on right box > close card onto box to secure left crate to left side of card

Step 10 Place 3rd smallest crate on top of 2nd middle crate > mark adhesive then use tear tape to secure

Step 11 Glue the right side of the barn door to the back

Step 12 Glue the back cover over the barn door

Step 13 Glue the front cover piece on the front card base

Step 14 Glue the left side only of the barn door (so you can place chicken hanging out)

Step 15 Decorate the front of the card

Note – I used transparencies with the chicken wire for the front of the crates

Although I am in the US, I did find that these measurements are easier to do in cm so I am providing both.
 Additionally, if you are making more than 1 card it is A LOT easier to make 1 set a template and only measure once

Largest Box
 14 x 18.5 cm
 5.5 x 7.5 inches

Crumb Cake
 Run through
 the hardwood
 embossing
 folder

- - - - - Score Line
- Cut Line
- Reference Line

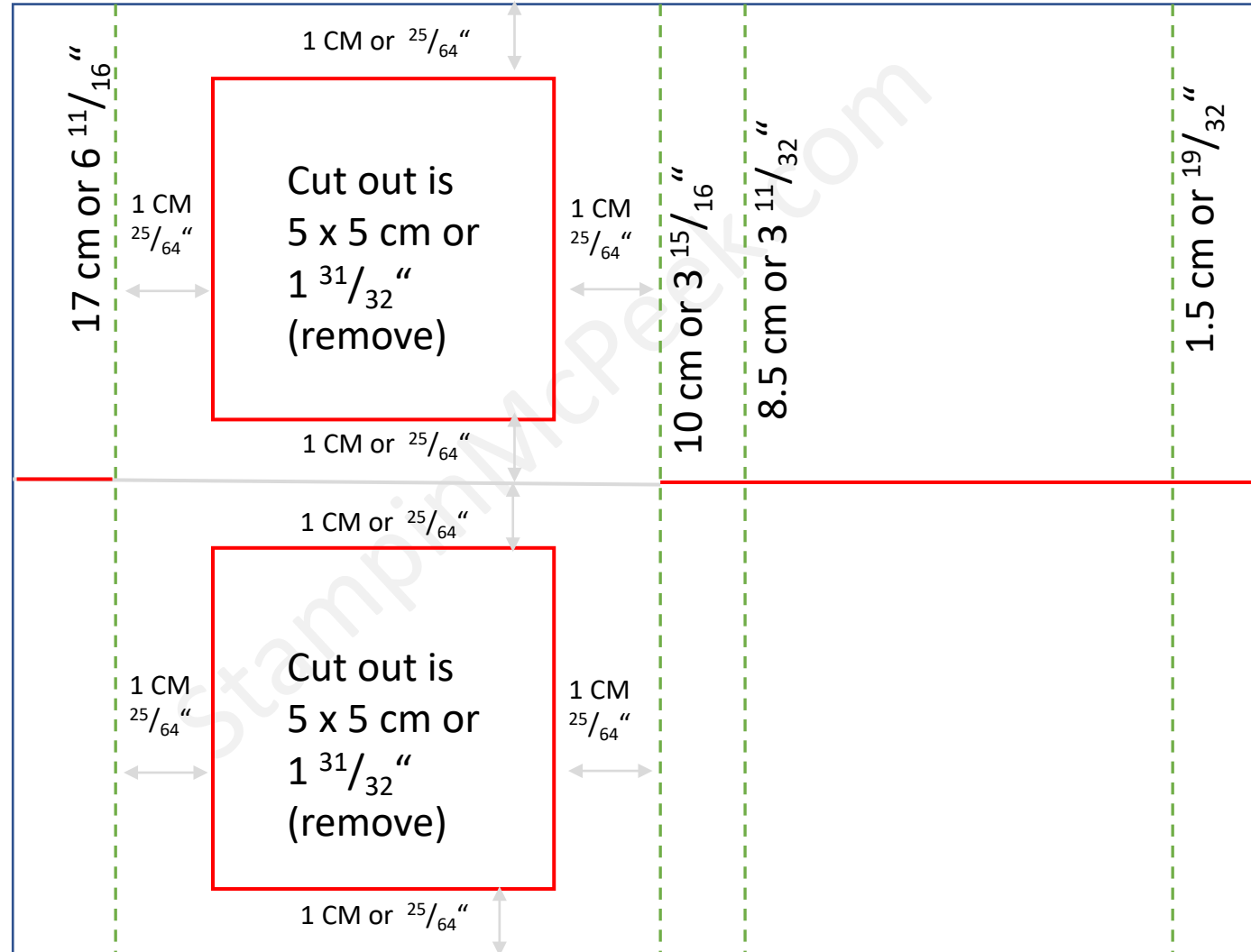

NOTE: On the medium box only – be sure to cut the front not the back

Medium Box

12 x 16.5 cm

4.5 x 6.5 inches

Crumb Cake

Run through the
hardwood
embossing folder

--- Score Line

— Cut Line

— Reference Line

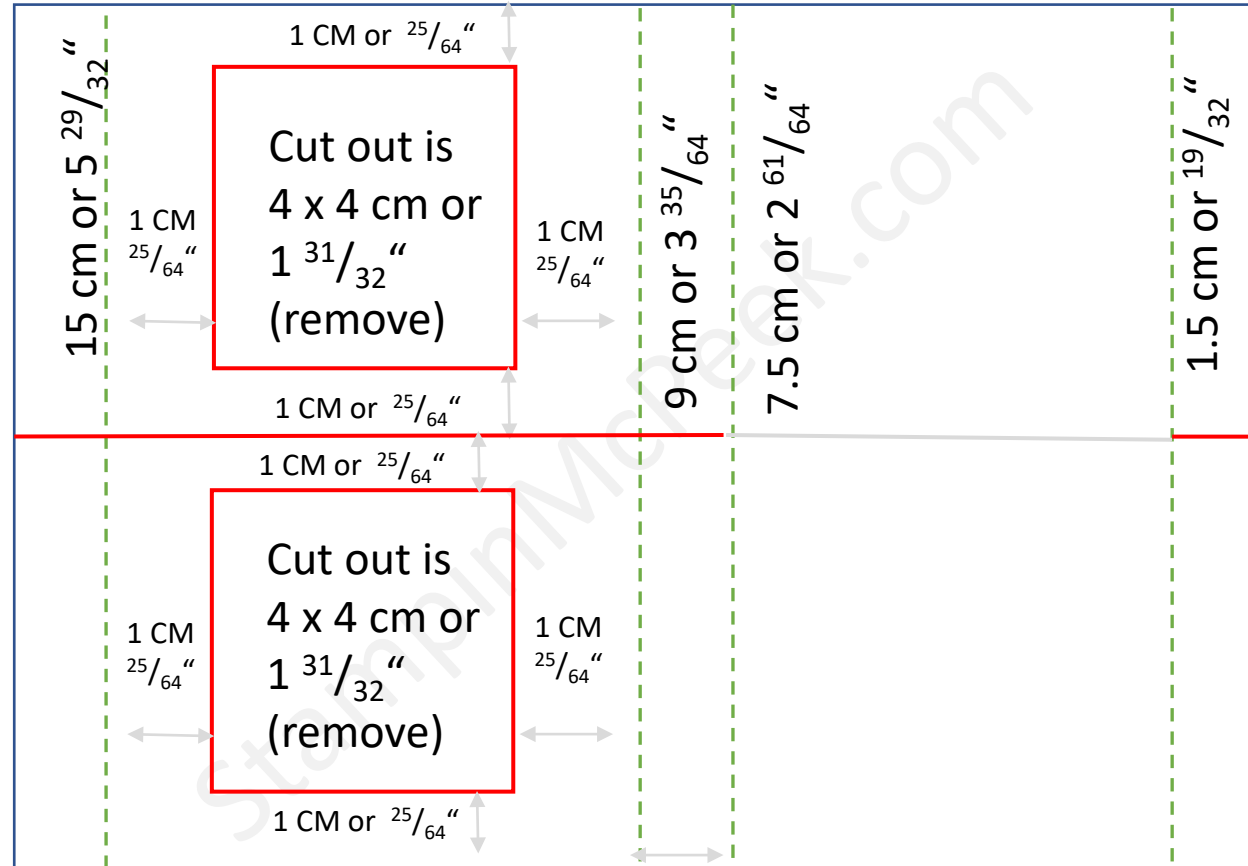

Small Box

10 x 14.5 cm

4 x 5 ⁴⁵/₆₄ inches

Crumb Cake

Run through the
hardwood

embossing folder

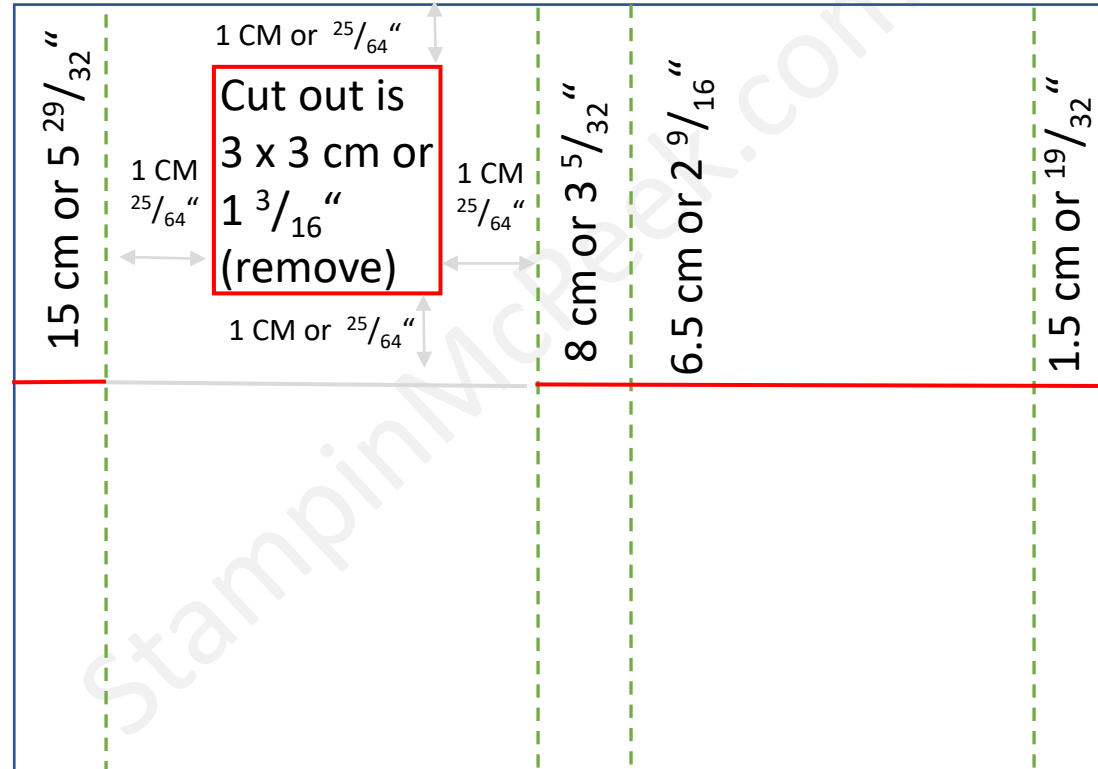

--- Score Line

— Cut Line

— Reference Line

Outside Card

30 x 15 cm

11 ¹³/₁₆ x 5 ²⁹/₃₂ inches

Black 12 X 12
cardstock for the card
base cut as above

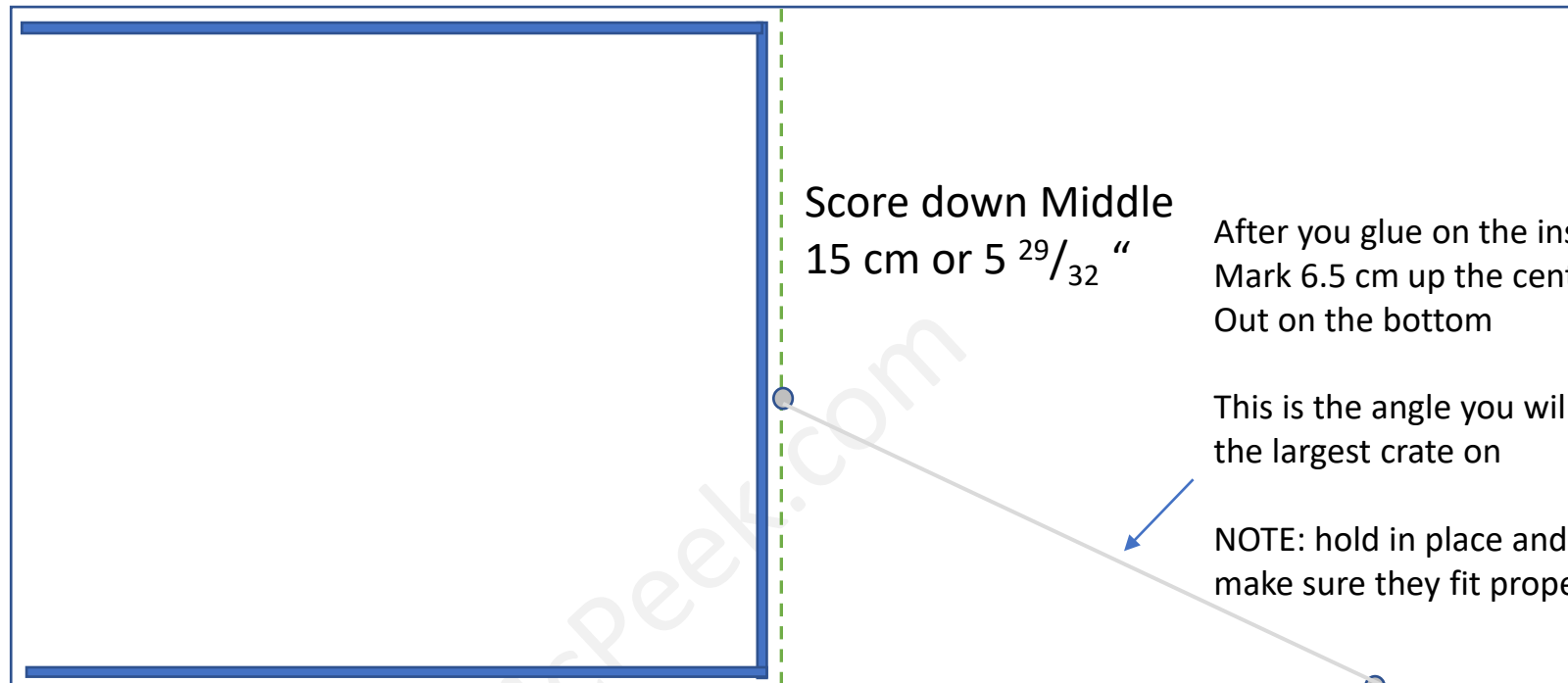

Score down Middle
15 cm or 5 ²⁹/₃₂ "

After you glue on the inside covers
Mark 6.5 cm up the center line & 12 cm
Out on the bottom

This is the angle you will glue the front of
the largest crate on

NOTE: hold in place and close boxes to
make sure they fit properly

Cut 4 pcs @
14.5 cm or 5 ²⁹/₃₂ "
2 for outside
2 for inside

Cut a ½ circle out of the inside
left pc to place a pull out
message card (that is what
the tear and tape is for)

Cover & inside pcs are
Crumb Cake
Run through the
hardwood embossing
folder

Rub crumb cake ink
pad over embossed
cardstock

- - - - - Score Line
- — — — — Reference Line
- ▬▬▬▬▬▬▬ Tear Tape

Barn Door

15 X 10 cm

5 ²⁹/₃₂ x 3 ¹⁵/₁₆ inches

Crumb Cake

Run through the
hardwood embossing
folder

Rub crumb cake ink
pad over embossed
cardstock

----- Score Line

————— Cut Line

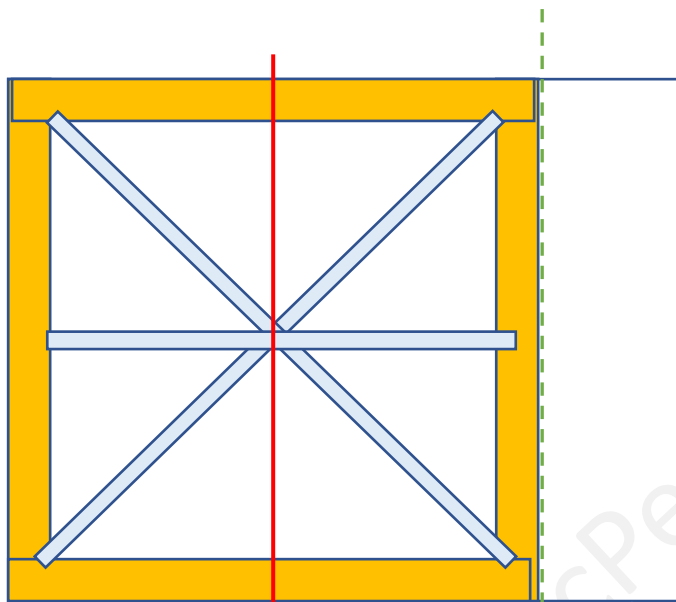

Score at
11.5 cm or 4 ¹⁷/₃₂ "

Note: wrap & glue
additional flap to the
back cardstock before
you glue on
decorative backing

Barn Door Accents

Crumb Cake

Run through the
hardwood embossing
folder

Rub crumb cake ink
pad over embossed
cardstock

Cut 4 Pcs 1/2" wide 

Cut 2 Pcs 1/4 wide 

After you glue wood
accents cut down
center